

Licht-Theremin

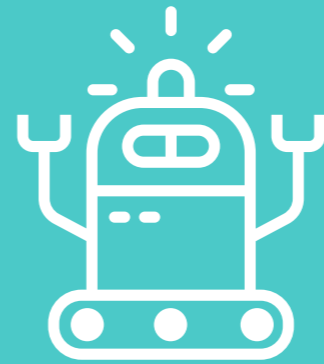

1

2

3

THEREMIN





Für diese Anleitung brauchst du:

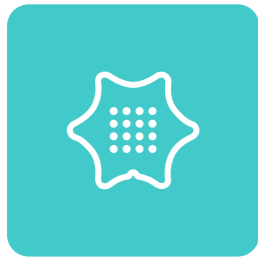

Calliope mini



Batterien



Bastelvorlage



Klebeband



Tonpapier

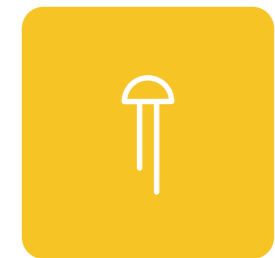

Klammer



Schere



mini box



Transparentpapier

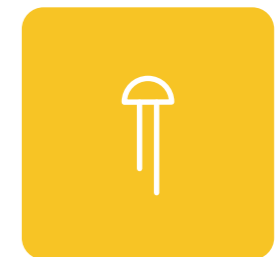

Klammer



Schneide die Bastelvorlage aus.

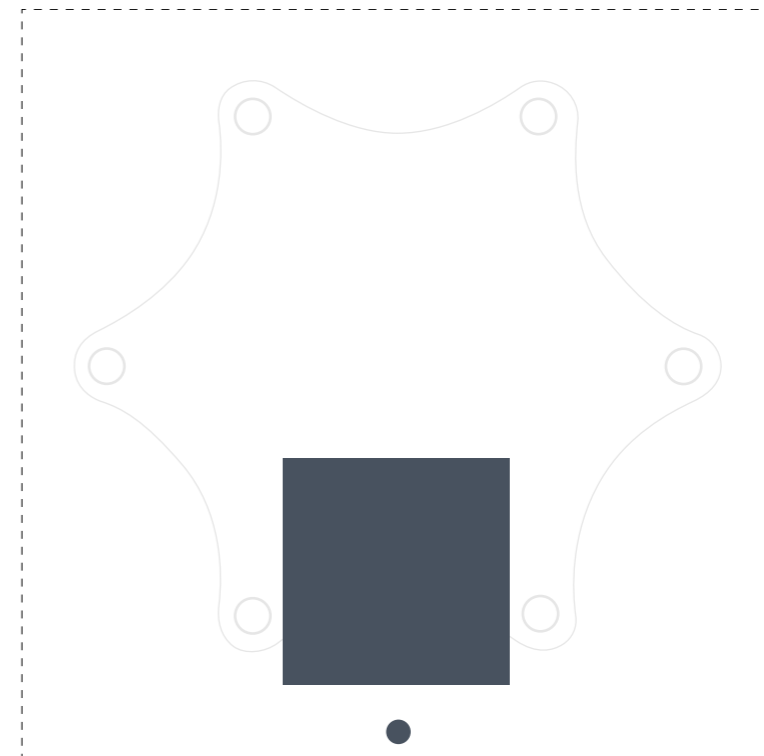



Klebe die ausgeschnittene Vorlage mit Klebeband von oben auf die mini box.

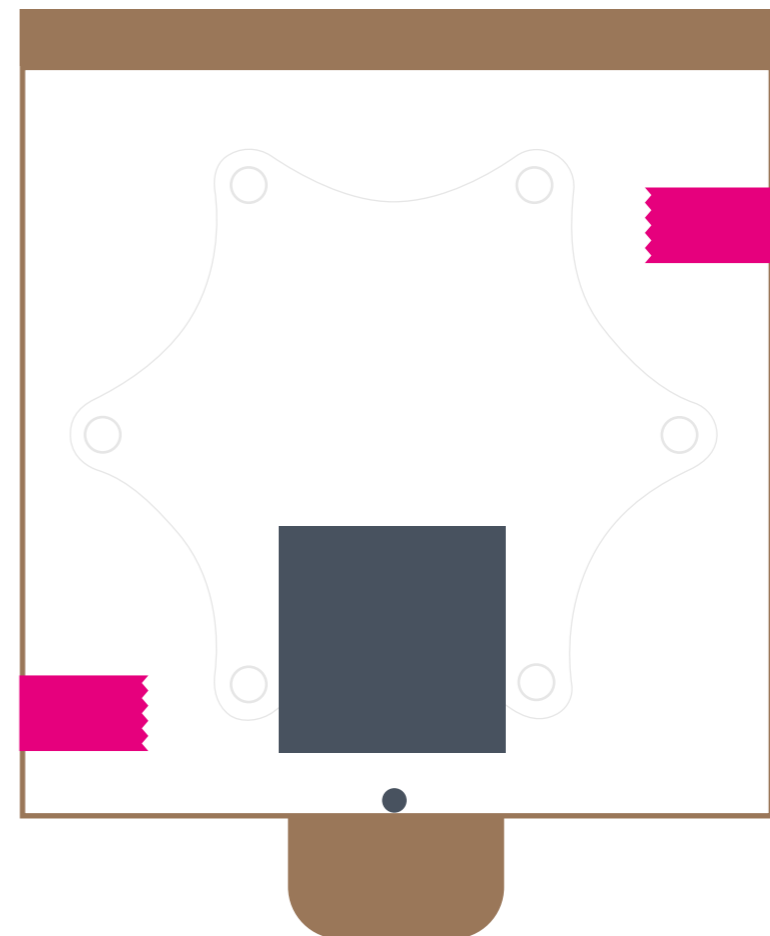



Steche vorsichtig mit einer Schere ein Loch in die mini box und schneide das Fenster und das darunter liegende Loch aus.

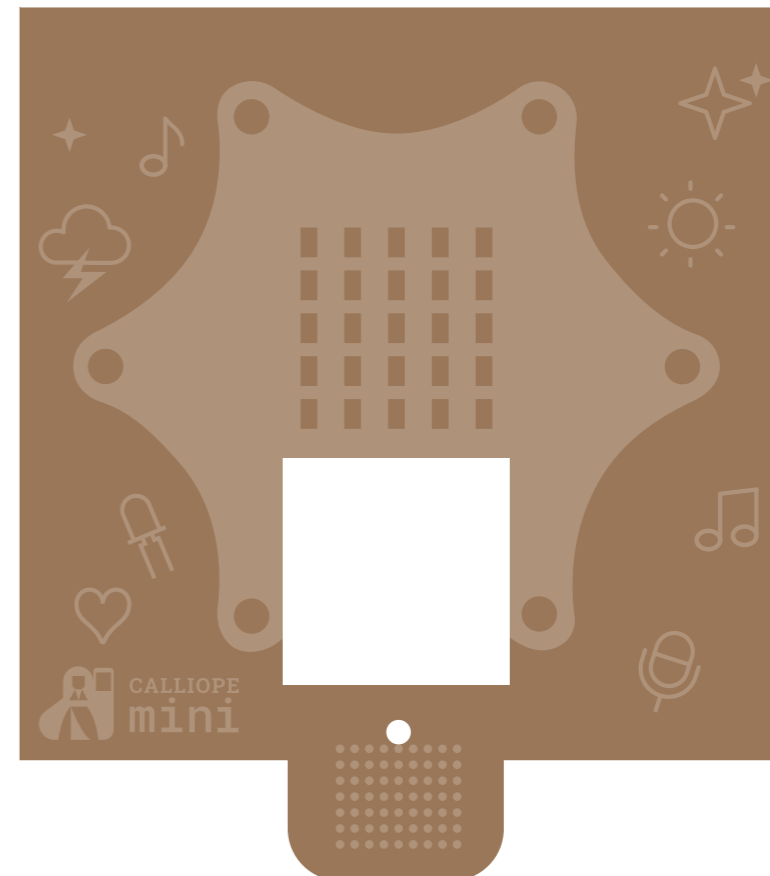



Schneide die Bastelvorlage für die Drehscheibe aus.
Lege sie auf das Tonpapier.

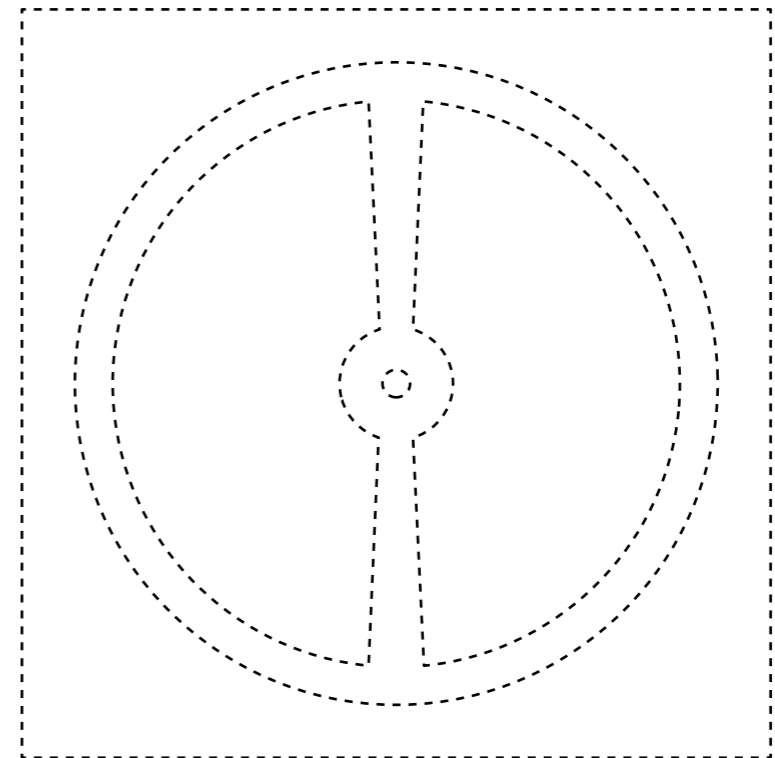



Benutze deine ausgeschnittene Schablone, übertrage die Form mit einem Stift auf das Tonpapier, schneide sie aus und bastele damit eine Drehscheibe aus Tonpapier.

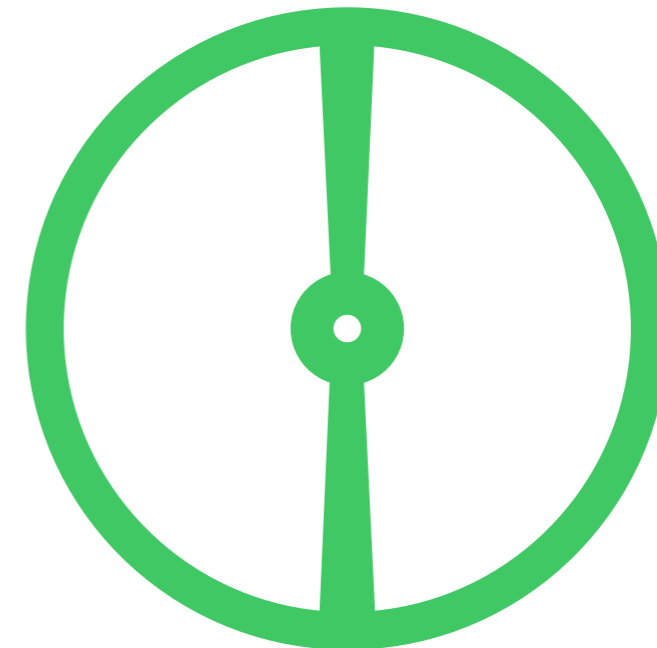

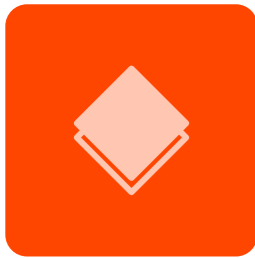

Schneide aus Transparentpapier und Tonpapier jeweils einen Halbkreis für die Fenster der Drehscheibe aus.

Steche vorsichtig Löcher in die Pappe.

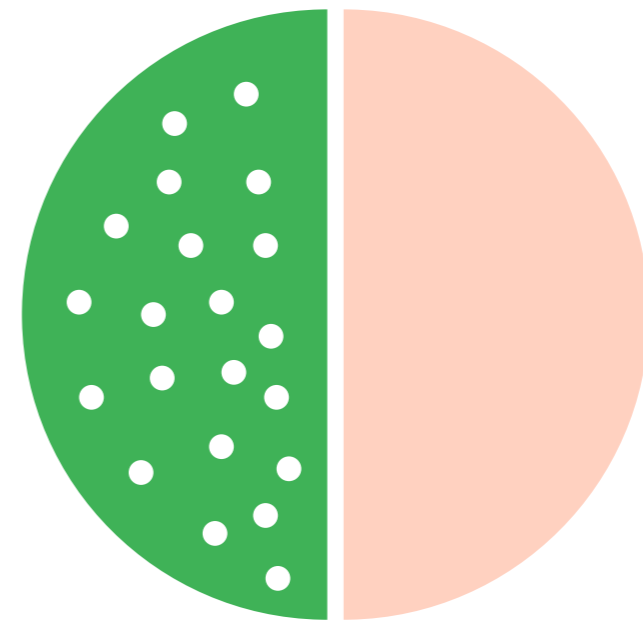



Klebe den Halbkreis aus dem gelöcherten Tonpapier und den Halbkreis aus Transparentpapier auf deine Drehscheibe.

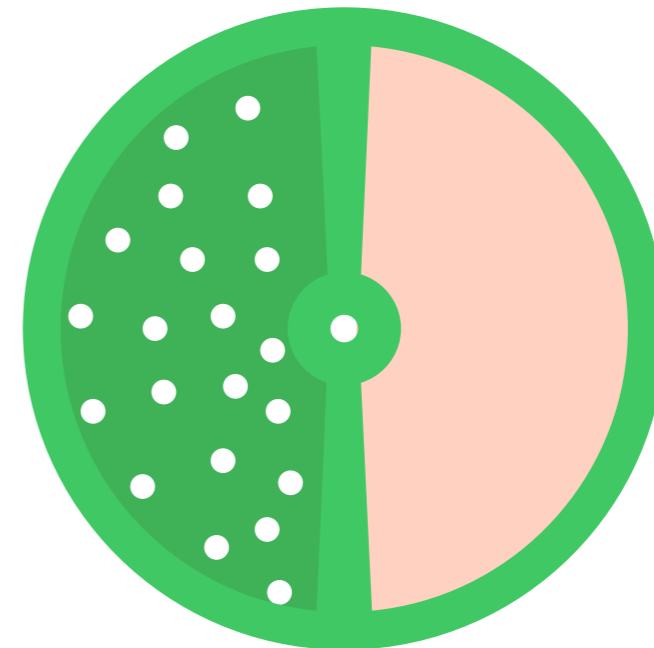



Befestige mit einer Klammer deine Drehscheibe an der mini box, in dem du sie von oben erst durch die mini box und dann durch die Drehscheibe führst.

Zum Schluss die Klammer durch Öffnen der Klammerbeine fixieren.

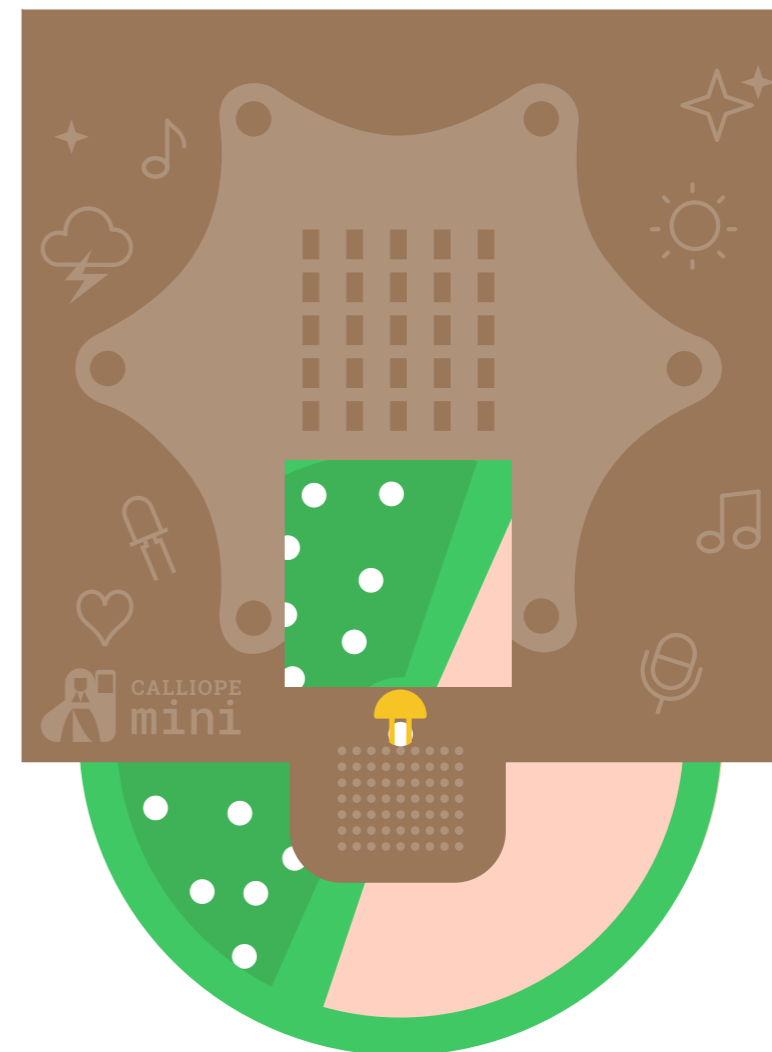

THEREMIN-BASTELVORLAGE

