

Light-Theremin

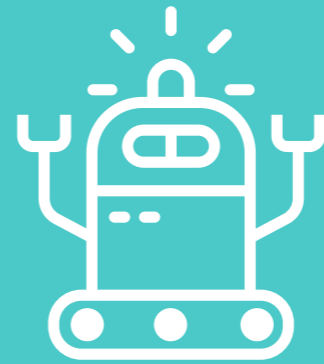

1

2

3

LIGHT-THEREMIN





What you will need:

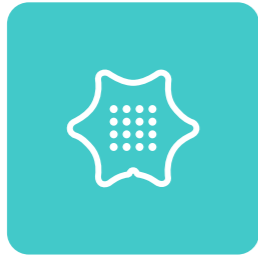

Calliope mini

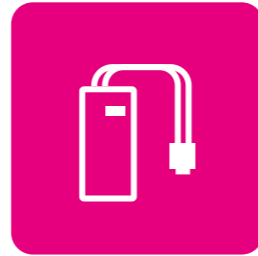

Batteries



Template



Tape



Paper

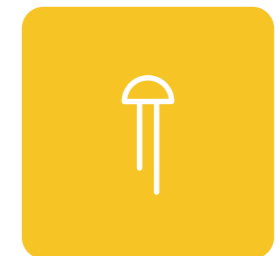

Staple



Scissors



mini box



Tracing paper



What you will need:

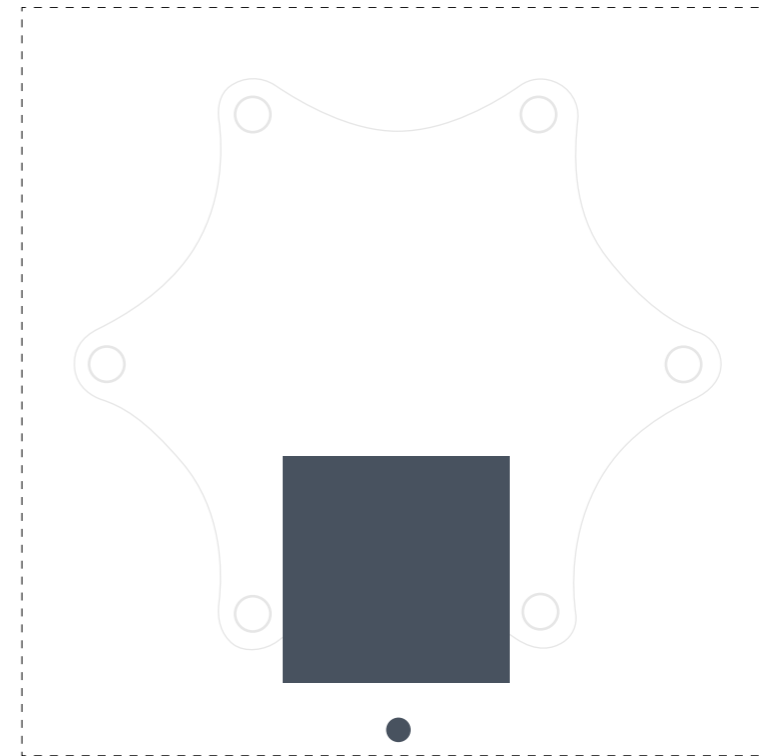



Stick the cut out pattern onto the mini box from above with sticky tape.

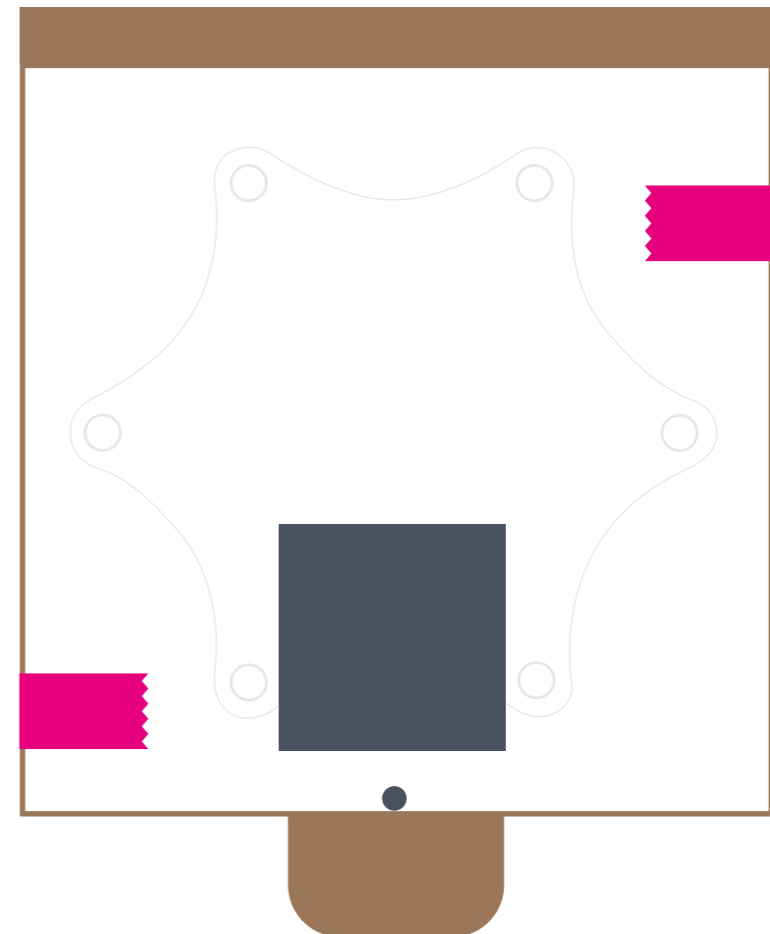



Carefully cut a hole in the mini box with scissors and cut out the window and the hole underneath.

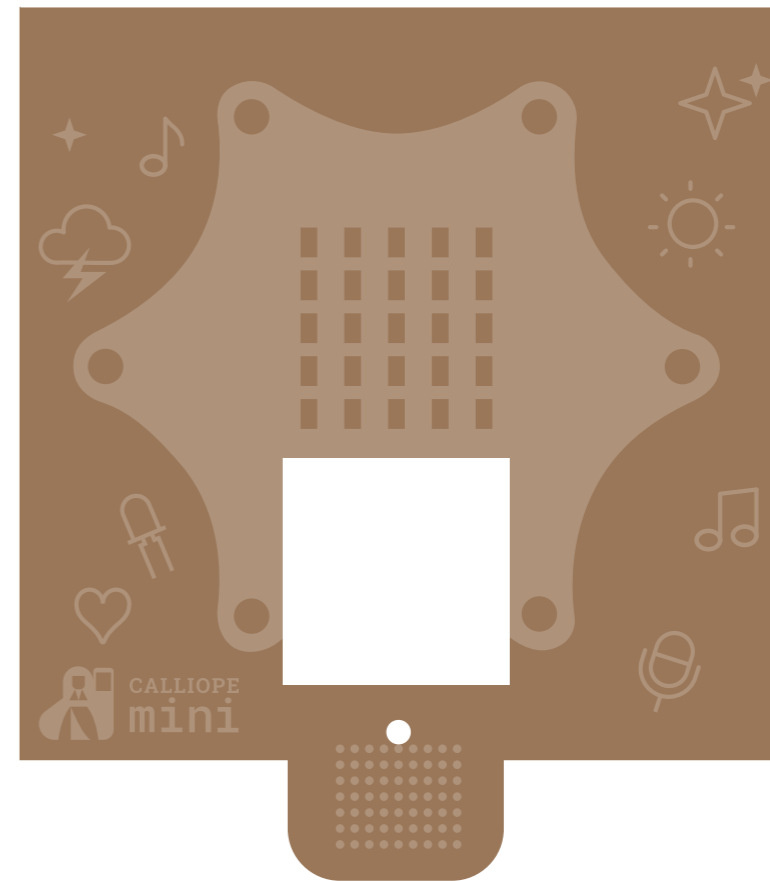



Cut the template for the turntable.
Put it on the paper.

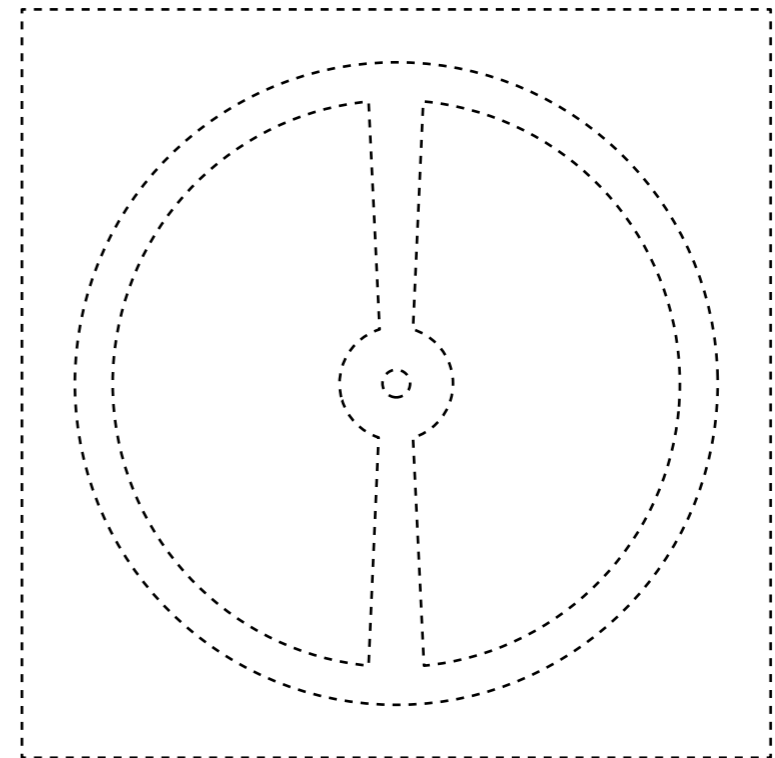



Use your cut out template, transfer the form with a pencil onto the paper, cut it and make a turntable out of colored paper with it.

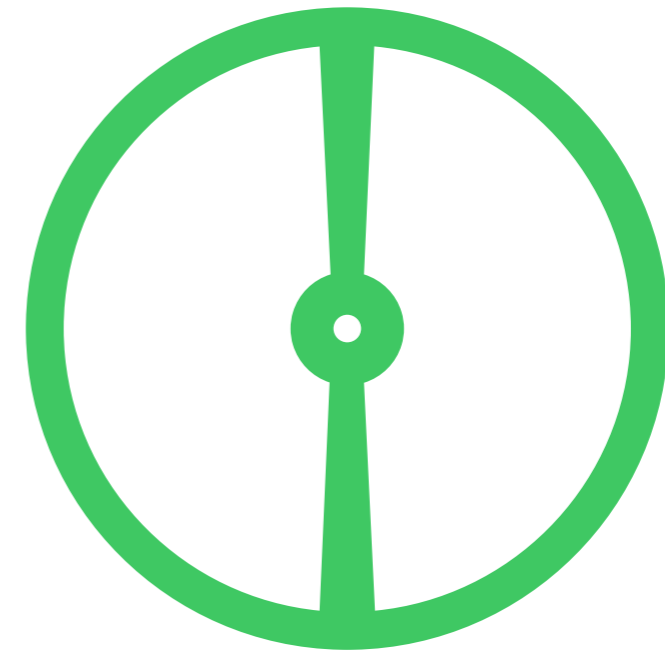

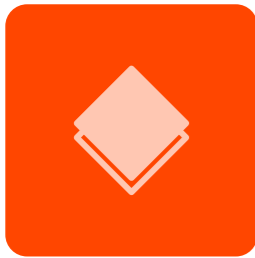

Cut a semicircle for each window of the turntable out of tracing paper and colored paper.

Carefully cut holes in the cardboard.

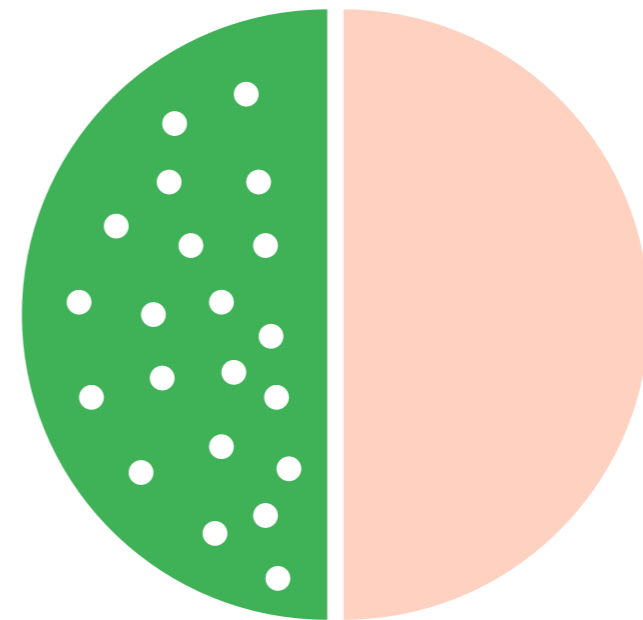



Stick the semicircle made of the perforated paper and the semicircle made of transparent paper onto your turntable.

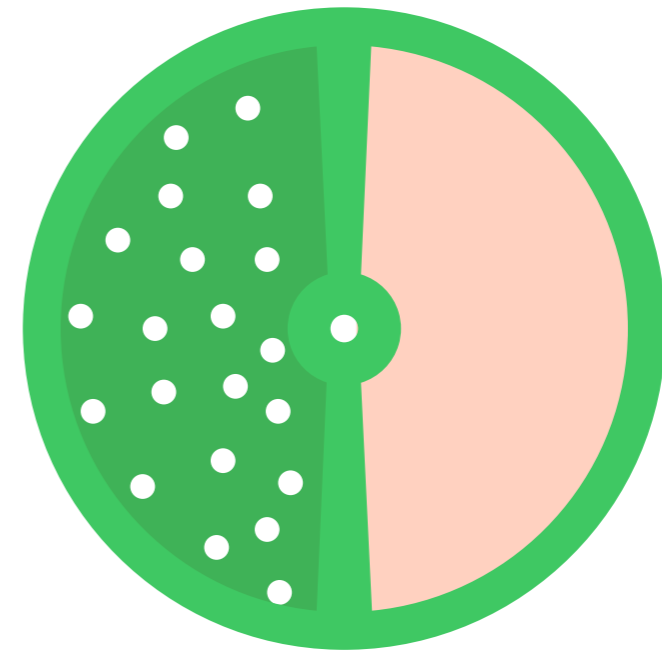



Use a staple to fasten your turntable to the mini box by first guiding it through the mini box from above and then through the turntable.

Finally fix the staple by opening it.

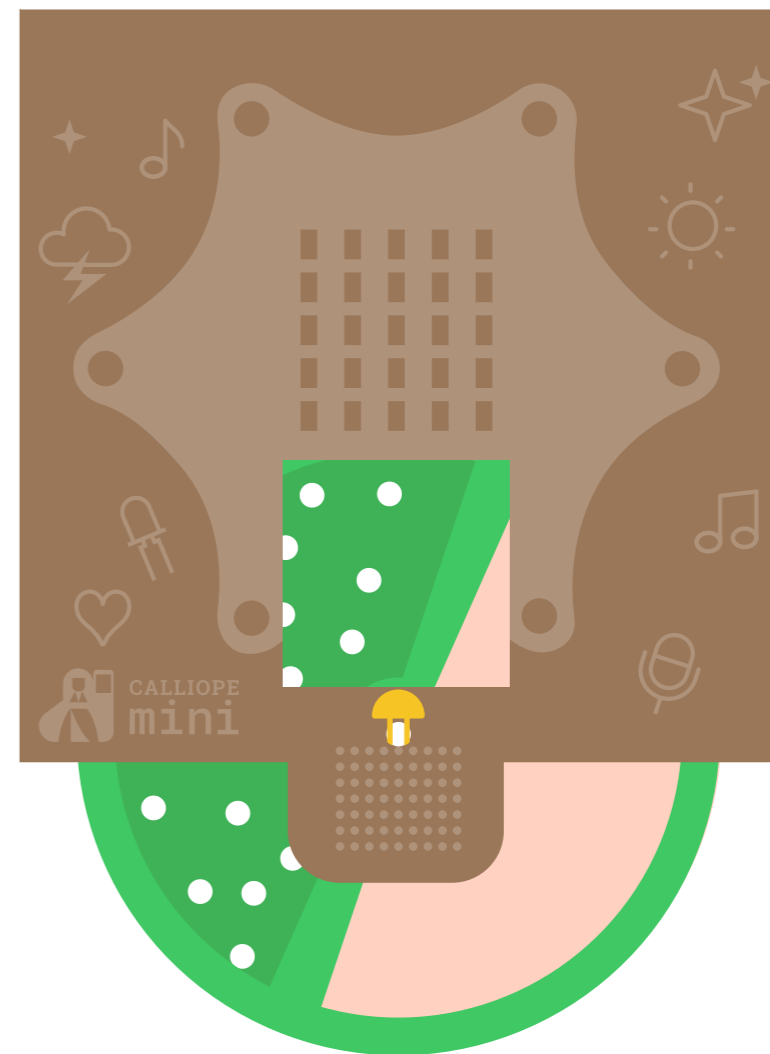

TEMPLATE

